

Operating Instructions

FUTURE**SAFE** 2.0



www.amf-bruns.de

Foreword

Dear Reader,

These Operating Instructions serve to provide all information required for the safe use of the FutureSafe 2.0 head and back supports.

The FutureSafe 2.0 is designed and constructed in accordance with state-of-the-art technology and recognised safety standards. Persons and material assets can however still be at risk, as not all danger areas can be eliminated if the functional capability is to be maintained. Accidents caused by these risks can however be prevented by strictly observing these Operating Instructions. Over and above this, the operational efficiency of your FutureSafe 2.0 can be used to the full and unnecessary faults can be prevented.

After reading these Operating Instructions for the first time, keep them in a safe place for future reference over the entire lifetime of the FutureSafe 2.0. If you sell the FutureSafe 2.0, hand these Operating Instructions over to the new owner.

Keep these Operating Instructions in the vehicle so that they can be referred to at any time when problems or questions arise.

All details, figures and dimensions given in these Operating Instructions are non-binding. They cannot be used as the basis for any claims whatsoever.

This document must not be reproduced or duplicated, in full or in part, without the prior, written permission of the manufacturer.

The FutureSafe 2.0 must be converted or modified in any way, without seeking the prior, written permission of the manufacturer. Unauthorised modifications will render the manufacturer's liability and guarantee null and void.

Use only original spare parts or spare parts which have been approved of by the manufacturer. If spare parts other than these are used, this can have a negative effect on the specified characteristics, the functionality and safety of the FutureSafe 2.0. The manufacturer will not accept liability for consequential damage if other spare parts are used.

Contact our customer services department to order spare parts or accessories (see Chapter 11, page 46).



NOTE

The current version of these Operating Instructions as well as the current versions of supplementary documents (e.g. the instructions for optional equipment) can be found under:

<https://www.amf-bruns-behindertenfahrzeuge.de/service/download-portal/>

Explanation of symbols and signs

To improve understanding, the following conventions should be met for these Operating Instructions:

1.

The following conventions are used to highlight important information:



DANGER!

- warns of a situation of immediate danger, which will lead to severe or fatal injuries if not avoided.
-
-



WARNING!

- warns of a potentially dangerous situation, which will lead to severe or fatal injuries if not avoided.
-
-



CAUTION!

- warns of a potentially dangerous situation, which will lead to slight or minor injuries or material damage if not avoided.
-
-



ATTENTION!

...warns of a potentially dangerous situation, which can cause material damage, if not avoided.



...contains general notes and useful information.



...gives a reference to important information contained in other sections and documents.

2.

Some text passages serve a special purpose. These are identified as follows:

- Lists.
- ⇒ Instructional text, e.g. a sequence of activities.

3.

Meaning of directions:

If directions are given in the text (in front of, front, behind, rear, right, left), these directions relate to the normal direction of travel of the vehicle.

Contents

1	Safety	8
1.1	Proper Use	9
1.2	Improper Use	9
1.3	User Requirements	10
1.4	Product Monitoring	10
1.5	Danger Zone	11
1.6	Safety and Accident Prevention Regulations	11
2	Description	13
2.1	Layout and Function	14
2.1.1	Floor or side anchorage	14
2.1.2	Frame	15
2.1.3	Head and back supports	16
2.1.4	Shoulder belt	16
2.1.5	Rating plate	17
2.2	Technical Data	17
3	Transportation	18
4	Installation / Commissioning	18
5	Operation	19
5.1	Safety Regulations for Operation	19
5.2	Adjustment Options	22
5.2.1	Pivoting the swivel arms	23
5.2.2	Extending and shortening the swivel arms	26
5.2.3	Adjusting the height of the head and back supports	28
5.2.4	Removing and fitting the head and back supports ...	31
5.2.5	Changing the thickness of the head and back supports by fitting cushions (optional)	32
5.2.6	Adjusting the FutureSafe 2.0 forwards or backwards	33



5.3	Adjusting the FutureSafe 2.0 for a Wheelchair-Bound Passenger	34
5.3.1	Adjusting the back support	34
5.3.2	Adjusting the headrest	35
5.4	Fastening the seat belts	37
6	Maintenance and Repair	39
6.1	Safety Regulations for Maintenance and Repair	39
6.2	Routine Maintenance Work	40
6.2.1	Maintenance schedule	40
6.2.2	Maintenance records	41
6.3	Maintenance and Repair Record	41
7	De-Commissioning and Conservation	42
8	Disposal	42
9	Faults and Troubleshooting	43
10	Spare Parts and Accessories	44
10.1	Spare parts	44
10.2	Accessories (optional)	45
11	Customer Service	46

1 Safety



WARNING!

There are a number of risks of suffering personal injury and material damage involved in the operation and maintenance of the FutureSafe 2.0.

Therefore:

- It is imperative, that these Operating Instructions are read thoroughly before operating the FutureSafe 2.0. Always observe the notes and information contained herein, in particular the Safety Instructions.
 - If these Operating Instructions or parts thereof are lost or become illegible, please request a new copy from the manufacturer.
-
-



For safety information regarding the basic vehicle, refer to the vehicle operating instructions.



For notes regarding the safety of the optional restraint and fastening systems, refer to the relevant Operating Instructions.

Prerequisite to the safe handling and trouble-free operation of the FutureSafe 2.0 is a thorough knowledge of the applicable safety information and the safety regulations.

It is therefore imperative that this Chapter is read thoroughly before operating the FutureSafe 2.0 and that the instructions and warnings herein are strictly observed. Safety Instructions and warnings that are given at the corresponding places in the text in the following Chapter must also be strictly observed. The manufacturer will not be held responsible if safety information and warnings are not strictly adhered to.

In addition to the information given in these Operating Instructions, local legislative regulations must be taken into consideration, in particular those regarding safety and accident prevention.

Observe the information given in these Operating Instructions even when there are no disabled persons being transported.

1.1 Proper Use

The FutureSafe 2.0 is designed solely for use in a vehicle to provide head and back support for persons seated in a wheelchair.

Whereby any person in the wheelchair must wear the shoulder belt provided on the FutureSafe 2.0 in addition to a suitable lap belt.

Any wheelchair to be transported in the vehicle must be tied down. In order to do this, the vehicle must be equipped with wheelchair restraint systems. The wheelchairs must be equipped with the necessary equipment for attaching the restraint systems. Wheelchairs that are used to carry passengers in vehicles must conform with ISO 7176-19.

Proper use also includes strictly adhering to the information given in these Operating Instructions.



WARNING!

If the FutureSafe 2.0 is used for any other purpose than that described above, this may result in dangerous situations for persons or material damage being caused.

Therefore:

- Only use the FutureSafe 2.0 for the purpose for which it was intended.
- Always adhere to information given in these Operating Instructions.
- Do not use the FutureSafe 2.0 for any other purposes, particularly those given in Section 1.2. These are deemed to be improper use.

1.2 Improper Use

Any use other than that described in Section 1.1 is deemed to be improper use.

The FutureSafe 2.0 is deemed to be improperly used if for example:

- it is used in a faulty state or with safety-relevant malfunctions,
- unauthorised modifications have been made to the FutureSafe 2.0,
- it is used to transport wheelchairs that cannot be tied down by means of the restraint systems provided,

- the wheelchair is not tied down in the vehicle,
- passengers in wheelchairs are not secured by shoulder and lap belts,
- the FutureSafe 2.0 is used to secure cargo loads or
- it is used by incompetent persons.

1.3 User Requirements

The FutureSafe 2.0 must only be handled by persons who:

- have read and understood these Operating Instructions,
- have proven their ability to operate the FutureSafe 2.0 to the vehicle's owner,
- have been expressly assigned by the vehicle's owner to operate the FutureSafe 2.0,
- are in a position to adapt themselves to the particular behaviour and needs of disabled persons.

Transportation, installation, commissioning, maintenance, repair, fault finding and disposal of the FutureSafe 2.0 must only be carried out by persons with the corresponding technical training and experience.

1.4 Product Monitoring

Please contact AMF-Brunns GmbH & Co. KG immediately if faults or problems are encountered when operating the FutureSafe 2.0 or if accidents or "near-misses" occur.

AMF-Brunns will effect a solution to the problem with your help and the knowledge gained will flow into future projects.



NOTE

Guarantee work on the FutureSafe 2.0 must only be carried out with the prior agreement of AMF-Brunns GmbH & Co. KG.

The costs of such work will not be accepted by AMF-Brunns without prior agreement.

1.5 Danger Zone

The danger zone is the area in which the head and back supports pivot within the interior of the vehicle on their swivel arms. Persons within the danger zone can suffer injuries through movements of the swivel arms.



WARNING!

Risk of injury through swivel arms not being correctly latched in position.

If the swivel arms are not latched in position, they can pivot unexpectedly when driving. There is a risk of injury.

Therefore:

- Before starting a journey, always make sure that both swivel arms are latched in position, even if there is no passenger or wheelchair protected by it.

1.6 Safety and Accident Prevention Regulations

Adhere to the following notes in order to prevent personal injuries and material damage. For commercial use, also adhere also to the relevant safety and accident prevention regulations laid down by the trade associations.

- The FutureSafe 2.0 must only be used for the purpose for which it is intended, otherwise dangerous situations, with resultant injuries, may occur (Proper use: see Section 1.1, page 9).
- The owner is responsible for ensuring that proper use is adhered to, in particular that the FutureSafe 2.0 is only operated by authorised persons.
- If the FutureSafe 2.0 is used commercially or communally, the owner must ensure that operating personnel are familiar with the operation of the FutureSafe 2.0 under all operating conditions by giving training and familiarisation courses.



- There is a risk of hands being crushed between the components of the FutureSafe 2.0 and other items when using the adjustment options of the FutureSafe 2.0. When making adjustments, take care to ensure that there is sufficient space and to grip components of the FutureSafe 2.0 in such a way that there is no risk of crushing.
- Proper use of the FutureSafe 2.0 also includes adherence to the specified maintenance and repair work, in particular the strict adherence to maintenance intervals. If such work is not carried out, trouble-free operation cannot be guaranteed. There is a risk of personal injury and material damage being caused. We recommend that maintenance records are kept.
- The FutureSafe 2.0 must not be operated in a faulty condition, as severe injuries may be caused by this. If faults occur, do not use the FutureSafe 2.0 until repairs have been effected.
- Use only original spare parts and accessories that have been approved of by the manufacturer. If other parts are used, the manufacturer will not accept liability for the consequences.

2 Description



For a description of the basic vehicle, refer to the vehicle Operating Instructions.



For a description of the optional restraint and tie-down systems, refer to the relevant Operating Instructions.

The FutureSafe 2.0 offers additional safety to persons who are riding in a car whilst seated in a wheelchair, by supporting the head and back in the event of an accident.

The main components of the FutureSafe 2.0 are:

- floor or side anchorage,
- the frame with pillar and swivel arms,
- the head and back supports,
- the shoulder belt.

The aim of this Chapter is to illustrate the construction and function of the FutureSafe 2.0. To this end, the individual assemblies and components are described in the sections that follow.

1

2

3

4

5

6

7

8

9

10

11

2.1 Layout and Function

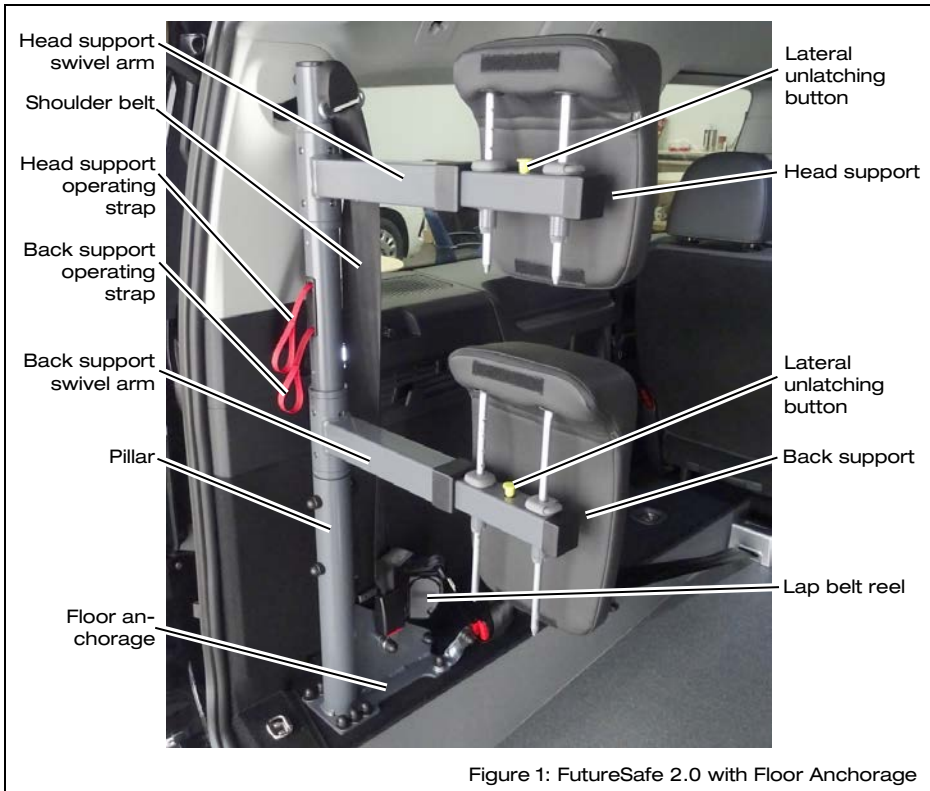

Figure 1: FutureSafe 2.0 with Floor Anchorage

2.1.1 Floor or side anchorage

The FutureSafe 2.0 is available with either a floor or side anchorage, by which it is firmly fixed to the vehicle.

A floor anchorage is firmly fixed to the floor of the vehicle using special assembly components. With this version, the belt reel for a lap belt is often fastened to the FutureSafe 2.0 (see Figure 1).

A side anchorage is particularly suitable for minibuses (see Figure 2, page 15). The FutureSafe 2.0 can be moved forwards or backwards in the vehicle by mounting it on Smartfloor rails. The FutureSafe 2.0 can also be easily removed from the vehicle.

Both versions of the FutureSafe 2.0 are available for installation on the right- or left-hand side of the vehicle.

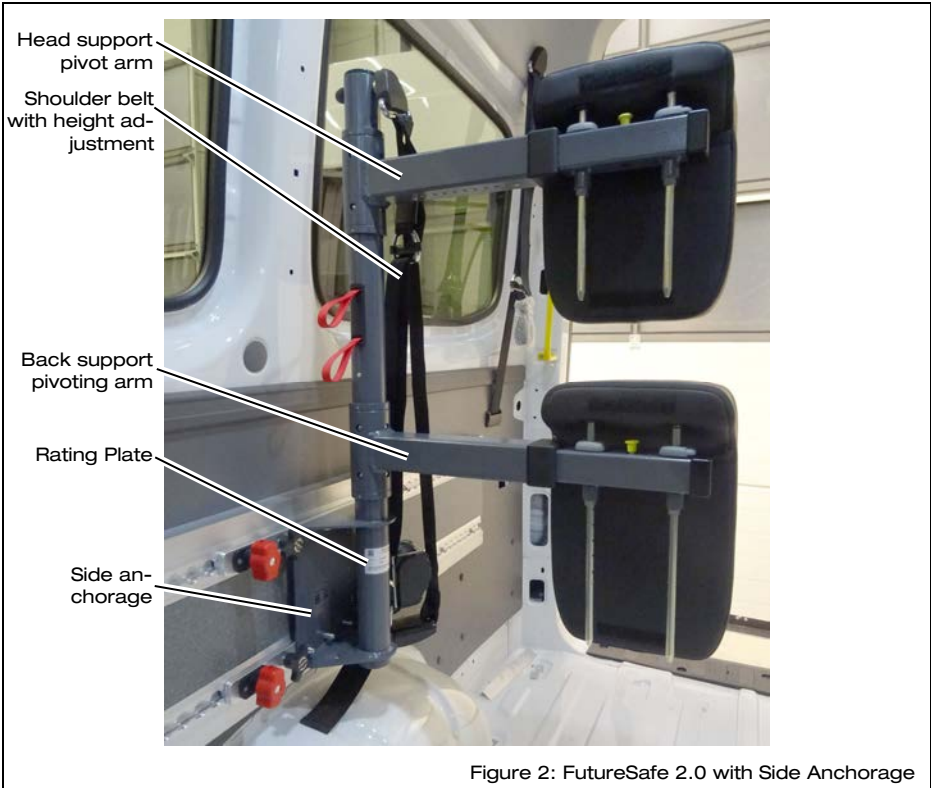

2.1.2 Frame

The main components of the frame are the pillar with floor or side anchorage and the swivel arms. The swivel arms can be pivoted around the pillar and are latched from the inside.

By pulling on the relevant operating strap, the swivel arm is unlatched and it can be pivoted. The swivel arm latches once again at 90° intervals when it is pivoted.

Each swivel arm has a telescopic function. The outer section can be pulled out or pushed in by pressing the lateral unlatching button. It can be latched in stages. This allows the head and back supports to be

1
2
3
4
5
6
7
8
9
10
11

separately laterally positioned exactly behind the passenger. Stoppers limit the range of movement to a safe level.

2.1.3 Head and back supports

The head and back supports are inserted, from above, into guides at the outer ends of the swivel arms. Both can be separately adjusted in height (in stages). A safety feature prevents the support from inadvertently being pulled out completely. The head or back support can be fully extended by pressing the height latch release button on the respective outer guide. Operation is similar to the headrests of original seats in many vehicles.

Cushions of different thickness can be attached to the head and back supports with Velcro fasteners. In this way, the distance between the head support and the passenger's head and the distance between the back support and the wheelchair can be optimally adjusted. These cushions are available through AMF-Brunns as optional extras (see Section 10.2, page 45).

2.1.4 Shoulder belt

The FutureSafe 2.0 is equipped with a shoulder safety belt with the belt reel attached at the bottom and a belt loop in the upper area. When travelling in the vehicle, the passenger in the wheelchair is protected by this shoulder safety belt and a suitable lap belt. The lap belt is not a component part of the FutureSafe 2.0 but can be attached to it. Alternatively, a lap belt can be fixed elsewhere in the vehicle or on the wheelchair itself.



NOTE

For safe use of the FutureSafe 2.0, the tie-down and restraint systems for wheelchair and passenger must conform with the applicable local standards.

If in doubt, contact AMF-Brunns GmbH, to find out whether the tie-down and restraint systems fitted to your vehicle are the correct systems (see Chapter 11, page 46).

2.1.5 Rating plate

A rating plate, which contains the fundamental data, is attached to the FutureSafe 2.0 (see Figure 3). The rating plate is attached to the pillar, in the vicinity of the floor or side anchorage (see Figure 2, page 15).

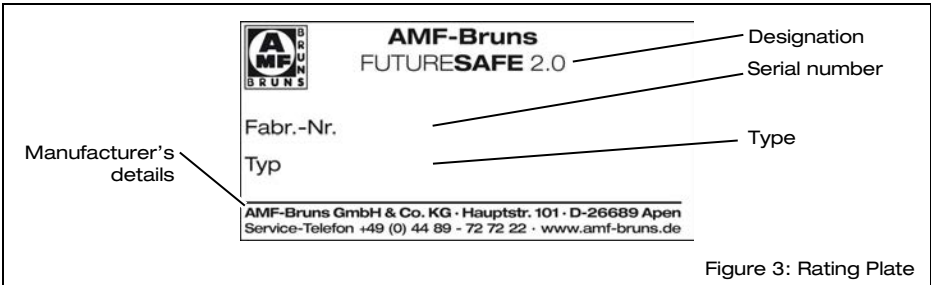

2.2 Technical Data

Designation	FutureSafe 2.0
Weight with floor anchorage (vehicle with rear cut-out)	22 kg
Weight with floor anchorage (large vehicle)	24 kg
Weight with side anchorage	19 kg



NOTE

Remember to take the weight of the installation materials (e. g. floor anchorage or Smartfloor rails) into consideration for the max. permissible gross weight of the vehicle.

3 Transportation

Transportation of the FutureSafe 2.0 is carried out by the manufacturer or by trained, experienced personnel.

4 Installation / Commissioning



The FutureSafe 2.0 must be installed in accordance with the AMF-Brunns Installation Instructions applicable to the vehicle in question.



DANGER!

Danger through incorrect installation work.

A number of risks of personal injury and material damage can be caused if the FutureSafe 2.0 is incorrectly installed in the vehicle.

Such risks of danger cannot only occur during installation but also as a result of installation not being carried out correctly.

Therefore:

- The FutureSafe 2.0 must only be installed by trained, specialist personnel.
 - The vehicle manufacturer's body fitting guidelines must be adhered to.
 - To ensure that the FutureSafe 2.0 has been installed correctly, it must be inspected by a technical expert.
 - The FutureSafe 2.0 must not be used until this has been done.
-

5 Operation



For information regarding the basic functions of the base vehicle, refer to the vehicle user manual.



For information regarding the operation of the additional systems for the carriage of passengers in wheelchairs and the additional restraint and tie-down systems, refer to their operating instructions.



NOTE

The FutureSafe 2.0 is not required to secure an unoccupied wheelchair during transportation.



NOTE

Depending upon the design of the wheelchair involved, it may be the case that the FutureSafe 2.0 cannot be appropriately positioned behind the passenger and the wheelchair. If this is the case, latch the swivel arms in the forward position and only use the shoulder belt and lap belt to secure the passenger.

5.1 Safety Regulations for Operation



The safety information given in the Safety chapter must have been read prior to operation (see Chapter 1, page 8).



WARNING!

Risk of injury and material damage if the FutureSafe 2.0 is operated in a faulty condition.

Therefore:

- Always visually inspect the FutureSafe 2.0 for signs of external damage before use.



WARNING!

Risk of injury and material damage if the FutureSafe 2.0 is operated by unauthorised persons.

Dangerous operating conditions may be caused if the FutureSafe 2.0 is operated by unauthorised persons.

Therefore:

- The FutureSafe 2.0 must only be operated by persons who are familiar with operating the FutureSafe 2.0.
 - The FutureSafe 2.0 must never be operated by the passenger.
-



WARNING!

Risk of injury if the FutureSafe 2.0 is operated when the vehicle is in motion.

If a passenger adjusts the FutureSafe 2.0 when the vehicle is in motion, it may no longer be effective under these circumstances. There is a risk of severe injuries being caused in the event of an accident.

Therefore:

- Make passengers aware of the dangers.
 - Make sure that the FutureSafe 2.0 is not adjusted by anyone when the vehicle is in motion.
-



WARNING!

Risk of injury through items on the FutureSafe 2.0.

If items are hung on the FutureSafe 2.0 (e.g. a hanging bag), they can be thrown around the vehicle during abrupt driving manoeuvres or in the event of an accident. There is a risk of the passenger in the wheelchair and of the other occupants in the vehicle being injured.

Therefore:

- Do not hang any items on the FutureSafe 2.0.
 - Make sure that no other persons hang items on the FutureSafe 2.0.
-

**CAUTION!**

Danger through items on the wheelchair backrest.

If items are left on the wheelchair backrest (e.g. a hanging bag), the effectiveness of the FutureSafe 2.0 may be compromised. There is a risk of severe injuries being caused in the event of an accident.

Therefore:

- Remove any items from the wheelchair backrest before pivoting the swivel arm into the driving position behind the wheelchair.

**WARNING!**

Risk of injury if the wheelchair and/or passenger are not secured correctly.

If the wheelchair and/or passenger is not correctly secured in the vehicle, passengers can suffer severe injury in an emergency braking situation or even a light road traffic collision.

Therefore:

- Always secure the wheelchair using the tie-down systems provided in the vehicle. Only tie the wheelchair down in the vehicle using the fastening points provided for this purpose on the wheelchair and in the vehicle.
- When the wheelchair is in the vehicle, it must always face in the direction of travel.
- Do not convey if the tie-down systems are not compatible with the fastening points on the wheelchair or in the vehicle.
- Make sure that the restraint systems for the wheelchair and passenger comply with local standards and regulations.
- Always restrain the passenger with both the shoulder and lap belts (see Section 5.4, page 37).
- Do not use the restraint systems foreseen for wheelchairs and persons for any other purpose (e.g. for securing loads).
- Always use the restraint systems, even for short journeys.
- If in doubt, contact AMF-Brunns GmbH, to find out whether the restraint systems fitted to your vehicle comply with local requirements (see Chapter 11, page 46).

1

2

3

4

5

6

7

8

9

10

11



WARNING!

Risk of injury if the incorrect sequence is used to secure the passenger.

If the correct sequence is not adhered to when preparing for a journey with a wheelchair and its passenger, the effectiveness of the safety measures may be compromised. There is a risk of severe injuries being caused in the event of an accident.

Therefore, always adhere to this sequence:

1. Pivot the FutureSafe 2.0 to the rear.
 2. Bring the wheelchair with passenger into position in the vehicle.
 3. Tie the wheelchair down.
 4. Fasten the safety belts on the passenger.
 5. Adjust the FutureSafe 2.0 as necessary and pivot it into position behind the passenger.
-

5.2 Adjustment Options

The FutureSafe 2.0 offers the following options to adjust it correctly to suit every situation:

- Pivoting the swivel arms(see Section 5.2.1, page 23),
- Extending and shortening the swivel arms (see Section 5.2.2, page 26),
- Adjusting the height of the head and back supports (see Section 5.2.3, page 28),
- Changing the thickness of the head and back supports by fitting cushions (optional) (see Section 5.2.5, page 32),
- Adjusting the FutureSafe 2.0 forwards or backwards (Only for FutureSafe 2.0 with side anchorage, see Section 5.2.6, page 33).

Further to this, removing and fitting the head and back supports is described in Section 5.2.4, page 31.

5.2.1 Pivoting the swivel arms

The swivel arms engage in their latches in 90° steps. The interior of the vehicle can be put to optimum use, to transport goods or passengers who are not in a wheelchair, when the swivel arms are pivoted towards the front of the vehicle (see Figure 4). The swivel arms are pivoted out of the vehicle in order to load a wheelchair-bound passenger (see Figure 5, page 24). When driving the vehicle with a wheelchair-bound passenger on board, the swivel arms are adjusted such that the head and back supports are located directly behind the passenger (see Figure 6, page 24).



Figure 4: Swivel Arms Pivoted Towards the Front

1

2

3

4

5

6

7

8

9

10

11

1
2
3
4
5
6
7
8
9
10
11



Figure 5: Swivel Arms Pivoted Towards the Rear



Figure 6: Swivel Arms in Position Behind the Wheelchair



Figure 7: Pull Operating Strap (Here: Head Support Swivel Arm)

- ⇒ Pull a swivel arm operating strap out horizontally using one hand, so that the latch disengages (see Figure 7).
- ⇒ Turn the swivel arm slightly in the desired direction using the other hand.
- ⇒ Release the operating strap.



WARNING!

Risk of injury through swivel arms not being correctly latched in position.

If one of the FutureSafe 2.0 swivel arms is not correctly latched in the required position, it will not provide protection to the passenger in the event of an accident. This will increase the risk of injury in the event of an accident.

If the swivel arms are not latched in position, they can pivot unexpectedly when driving. There is a risk of injury.

Therefore:

- Always pivot a swivel arm as far as necessary, until the latch audibly engages.
- Check that it is latched by shaking it vigorously.
- Visual inspection, to check that all eight latching balls in each swivel arm are pushed outwards into the holes at every latching position.

- ⇒ Pivot the swivel arm further to the desired direction, until the latch audibly engages in the next position.
- ⇒ Vigorously shake the swivel arm to make sure that the latch is engaged.
- ⇒ Repeat the procedure if the swivel arm is to be pivoted to the next position.

5.2.2 Extending and shortening the swivel arms



WARNING!

Risk of injury if the FutureSafe 2.0 is not adjusted correctly.

If the FutureSafe 2.0 is not adjusted for optimum protection of the passenger, there is an increased risk of injury.

Therefore:

- Make full use the FutureSafe 2.0 adjustment options.
 - Adjust the head and back support swivel arms laterally, such that they support the centre of the passenger and wheelchair.
 - Make sure that the latch is engaged after making any adjustment.
-

Lateral adjustment of the swivel arms serves precisely position the head and back supports behind the centre of the passenger and wheelchair.



Figure 8: Press Lateral Unlatching Button

- ⇒ Press the lateral unlatching button, on the outer part of the swivel arm, down (see Figure 8).
- ⇒ Push the outer part of the swivel arm to the desired position whilst holding the lateral unlatching button down (see Figure 9, page 28).
- ⇒ Release the unlatching button.
- ⇒ Push the outer part of the swivel arm in or out slightly, until the latch audibly engages.
- ⇒ Vigorously pull or push the outer part of the swivel arm to make sure that the latch is engaged.

1
2
3
4
5
6
7
8
9
10
11



Figure 9: Swivel Arm, Extended

5.2.3 Adjusting the height of the head and back supports

The height of the head and back supports can be independently adjusted in stages. The passenger in the wheelchair is afforded the maximum possible safety by adjusting them to the correct height.



WARNING!

Risk of injury if the FutureSafe 2.0 is not adjusted correctly.

If the FutureSafe 2.0 is not adjusted for optimum protection of the passenger, there is an increased risk of injury in the event of an accident.

Therefore:

- Make full use the FutureSafe 2.0 adjustment options.
- Adjust the height of the head and back supports, such that they provide the best possible support the passenger and wheelchair.
- Make sure that the latch is engaged after making any adjustment.



Refer to Note Section 5.3, page 34, to adjust the FutureSafe 2.0 to best suit a passenger in a wheelchair.

Heightening the head and back supports

- ⇒ In order to heighten the head or back support, pull it upwards to the desired position.
- ⇒ Push the head or back support downwards a little, until it can be felt to latch at both sides.



Figure 10: Head Support at the Maximum Height

Lowering the head and back supports

- ⇒ Push the height unlatching button on the head or back support (see Figure 11).

1
2
3
4
5
6
7
8
9
10
11



Figure 11: Press Height Unlatching Button

- ⇒ In order to lower the head or back support, push it downwards to the desired position.
- ⇒ Release the height unlatching button.
- ⇒ Push the head or back support downwards a little, until it can be felt to latch at both sides.



Figure 12: Head Support at the Minimum Height

5.2.4 Removing and fitting the head and back supports

The head and back supports can be removed, e.g. for cleaning purposes.



WARNING!

Risk of injury if the FutureSafe 2.0 is not operated correctly.

If the FutureSafe 2.0 is not operated correctly, there is an increased risk of injury in the event of an accident.

Therefore:

- Do not use the FutureSafe 2.0 if the head and/or back supports have been removed.
- When the head and back supports are fitted once again, make sure that they are far enough into their guides and within their normal range of adjustment.

Removing the head and back supports

- ⇒ If the back support is to be removed, the head support swivel arm must be pivoted to a different position than the back support swivel arm.
- ⇒ Move the head or back support to the highest position.
- ⇒ Push the height unlatching button on the head or back support (see Figure 11, page 30).
- ⇒ Holding the height unlatching button pressed and pull the head or back support further upwards, until it is free.

Fitting the head and back supports

- ⇒ If the back support is to be fitted, the head support swivel arm must be pivoted to a different position than the back support swivel arm.
- ⇒ Insert the head or back support from above into the guides at the outer end of the swivel arm.
- ⇒ Push the head or back support evenly downwards, until it can be felt to latch in the first position at both sides.
- ⇒ Adjust the height of the head or back support as necessary.

5.2.5 Changing the thickness of the head and back supports by fitting cushions (optional)

The distance between the head support and the passenger's head and the distance between the back support and the wheelchair can be optimally adjusted using cushions of differing thickness. These cushions are available through AMF-Brunns as optional extras (see Section 10.2, page 45).



Refer to Note Section 5.3, page 34, to adjust the FutureSafe 2.0 to best suit a passenger in a wheelchair.

- ⇒ Press the Velcro strip on the flap of the cushion horizontally and centrally onto the Velcro strip on the head or back support.

- ⇒ Fold the flap on the cushion over the head or back support so that the cushion hangs down the front of the head or back support.
- ⇒ Press the Velcro fastening strips firmly together.
- ⇒ To remove the cushion, separate the Velcro fastener by pulling the flap on the cushion away from the support.

5.2.6 Adjusting the FutureSafe 2.0 forwards or backwards

Only the FutureSafe 2.0 with a side anchorage can be adjusted forwards or backwards.

- ⇒ Turn the red locking levers to the vertical position (see Figure 13, page 33).
- ⇒ Loosen the securing screws by turning the black star grips.

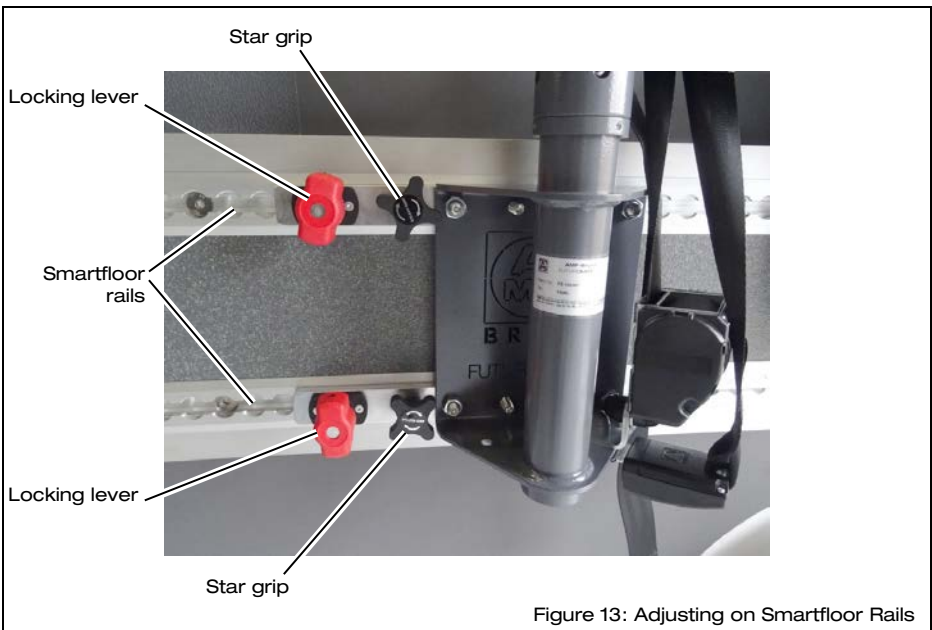

Figure 13: Adjusting on Smartfloor Rails

- ⇒ Push the FutureSafe 2.0 forwards or backwards to the desired position.

- ⇒ Turn the red locking levers back to the horizontal position.
- ⇒ Push the FutureSafe 2.0 forwards or backwards slightly, until both locking levers audibly latch
- ⇒ Tighten the securing screws by turning the star grips.

5.3 Adjusting the FutureSafe 2.0 for a Wheelchair-Bound Passenger



WARNING!

Risk of injury if the FutureSafe 2.0 is incorrectly adjusted.

If the FutureSafe 2.0 is not adjusted correctly, it cannot provide the passenger with optimum safety in the event of an accident.

Therefore:

- Observe the notes given in this Section when adjusting the FutureSafe 2.0.
 - Adjust the back support first, followed by the head support.
-

Figure 14, page 36, shows a schematic view of the optimum adjustment for the FutureSafe 2.0.

5.3.1 Adjusting the back support

- ⇒ Wheel the wheelchair into position in the vehicle.
- ⇒ For a wheelchair with a backpack: Empty the backpack or remove it from the wheelchair.
- ⇒ Pivot the back support to a position behind the passenger and allow the latch to engage (see Section 5.2.1, page 23).
- ⇒ Adjust the length of the swivel arm, such that the back support is positioned in the centre of the passenger's back (see Section 5.2.2, page 26).

- ⇒ Adjust the back support forwards or backwards in the following way, so that it rests against the passenger's back:

For FutureSafe 2.0 with floor anchorage: Move the wheelchair forwards or backwards accordingly. Take note that the possible positions may be limited by the wheelchair restraint systems.

For FutureSafe 2.0 with side anchorage: Move the FutureSafe 2.0 on the Smartfloor rails accordingly (see Section 5.2.6, page 33).

- ⇒ Adjust the height of the back support, such that the upper edge is positioned in the shoulder region of the passenger (see Section 5.2.3, page 28).
- ⇒ Change the fine setting of the back support if necessary, using a cushion (see Section 5.2.5, page 32).

5.3.2 Adjusting the headrest

- ⇒ Pivot the headrest to a position behind the passenger and allow the latch to engage (see Section 5.2.1, page 23).
- ⇒ Adjust the length of the swivel arm, such that the headrest is positioned in the centre of the passenger's head (see Section 5.2.2, page 26).
- ⇒ Adjust the height of the headrest, such that the upper edge is at the same height as the top of the passenger's head (see Section 5.2.3, page 28).
- ⇒ Change the fine setting of the head support if necessary, using a cushion (see Section 5.2.5, page 32).



NOTE

Remember that the FutureSafe 2.0 adjustment described here represents the ideal case.

Persons who are dependent upon a wheelchair are not always in a position to assume a posture as shown in Figure 14, page 36.

Always try to find a balance between maximum protection and maximum comfort of the passenger.

1
2
3
4
5
6
7
8
9
10
11

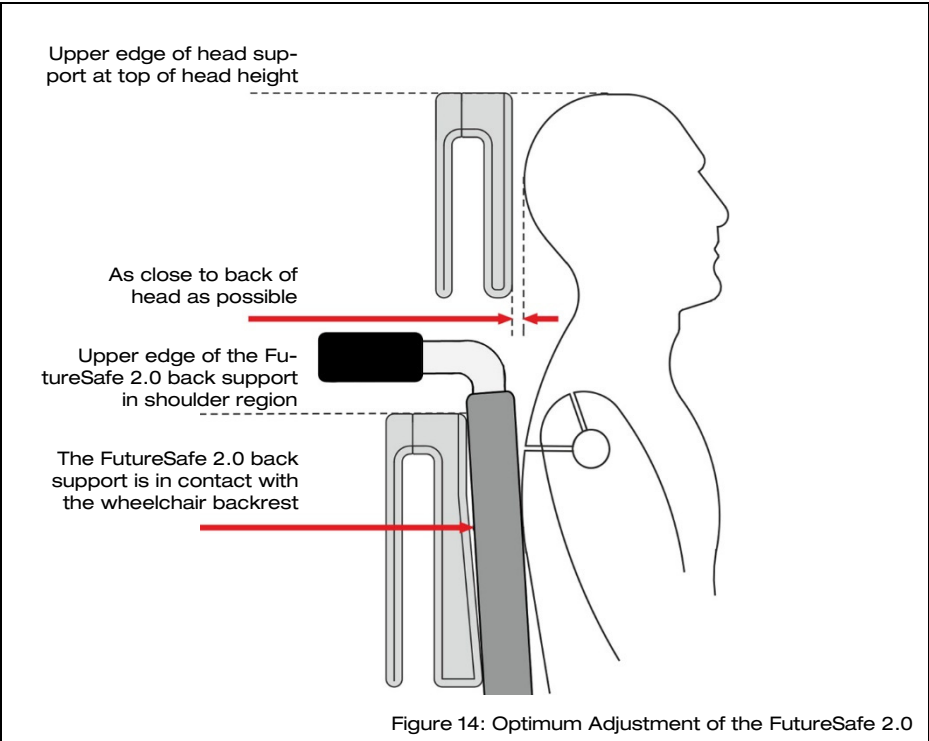

5.4 Fastening the seat belts



WARNING!

Risk of injury if the seat belts are incorrectly adjusted.

If the seat belts are incorrectly adjusted, they will not provide the passenger with maximum safety in case of an accident or can present a source of danger in themselves.

Therefore:

- Do not lay the lap belt over the armrests of the wheelchair.
 - Make sure that the lap belt lies across the lap of the passenger.
 - If the belt does not lie across the lap of the passenger but lies across the stomach, it is too high.
 - If in doubt, contact AMF-Bruns GmbH, to find out whether the restraint systems fitted to your vehicle comply with local requirements (see Chapter 11, page 46).
-

⇒ Secure the wheelchair with the restraint systems provided in the vehicle.

⇒ Restrain the wheelchair passenger in place with the lap belt provided for this (see Figure 15, page 38, and Figure 16, page 38).

Do not pass the lap belt over the armrests of the wheelchair.

⇒ If necessary, adjust the length of the lap belt so that it holds the passenger firmly without being too tight.

⇒ Restrain the wheelchair passenger in place with the FutureSafe 2.0 shoulder belt (see Figure 15, page 38, and Figure 16, page 38).

Lead the belt diagonally across the passenger's upper body and between the backrest and armrest of the wheelchair towards the rear. Insert the shoulder belt buckle into the belt latch provided for this purpose on the wheelchair restraint system or on the lap belt.

1

2

3

4

5

6

7

8

9

10

11

- 1
- 2
- 3
- 4
- 5
- 6
- 7
- 8
- 9
- 10
- 11



6 Maintenance and Repair



Refer to the manufacturer's Operating Instructions and service documents for information regarding the fundamental maintenance of the basic vehicle.



For notes regarding the safety of the optional restraint and fastening systems, refer to the relevant Operating Instructions.

6.1 Safety Regulations for Maintenance and Repair



Read the safety information before carrying out maintenance and repair work (see Chapter 1, page 8).



WARNING!

Risk of injury and material damage if maintenance and repair work is not carried out correctly.

Therefore:

- Only allow specialist personnel to carry out maintenance and repair work.
- If repair work has been carried out on load bearing parts, this must be inspected by a technical expert.



WARNING!

Personal injury and material damage can be caused by using inferior quality spare parts.

The manufacturer will accept no liability whatsoever for damage or injury caused by the use of non-original spare parts or spare parts that have not been approved of by the manufacturer.

Therefore:

- Use only original spare parts or spare parts that have been approved of by the manufacturer.



WARNING!

There is a risk of injury if the FutureSafe 2.0 is used after the vehicle has been involved in an accident.

The FutureSafe 2.0 can suffer damage, which is not immediately evident, if involved in an accident. This can adversely affect the safety of the passenger in the wheelchair.

Therefore:

- The FutureSafe 2.0 must be replaced if the vehicle is involved in an accident.
- If in doubt, contact the customer service department for advice on whether it is safe to use the FutureSafe 2.0 if it was only involved in a minor accident (see Chapter 11, page 46).

6.2 Routine Maintenance Work

The maintenance schedule below lists the maintenance work that must be carried out on the FutureSafe 2.0 at regular intervals.

Contact the customer service department for maintenance work that must only be carried out by a specialist (see Chapter 11, page 46).

6.2.1 Maintenance schedule

Interval	Activity
Every time used	Carry out a visual inspection for damage and deficiencies. Initiate repairs if necessary.
monthly	Check the latching positions of the swivel arms: <ul style="list-style-type: none"> • Visual inspection, to check that all eight latching balls in each swivel arm are pushed outwards into the holes at every latching position. • Check that the swivel arm latches in every latching position by shaking it vigorously. Initiate repairs if necessary.
	Checking the FutureSafe 2.0 fastenings. <ul style="list-style-type: none"> • Visual inspection of all screwed connections. • Check by shaking the upper part of the pillar. Initiate repairs if necessary.

6.2.2 Maintenance records

Enter maintenance and repair work that has been carried out into the maintenance record provided for this purpose (see Section 6.3). This provides a traceable record of maintenance work.

For records of maintenance work over and above this, it is recommended that you keep your own lists.

6.3 Maintenance and Repair Record

Maintenance Work Carried Out		
Date	Signature	Remarks / work carried out



7 De-Commissioning and Conservation

For queries regarding de-commissioning and conservation, contact our customer services department (see Chapter 11, page 46).

8 Disposal

When the FutureSafe 2.0 useful life has expired, it must only be disposed of by qualified specialists. The manufacturer will accept no liability for damage caused by incorrect disposal.

- 1
- 2
- 3
- 4
- 5
- 6
- 7
- 8
- 9
- 10
- 11

9 Faults and Troubleshooting



WARNING!

Risk of severe injury and material damage if repair work is carried out incorrectly.

Therefore:

- Only allow specialist personnel to carry out repair work.



For fundamental information regarding faults on the basic vehicle, refer to the vehicle operating instructions.



For information regarding faults and troubleshooting of the optional restraint and fastening systems, refer to the relevant Operating Instructions.

If faults occur when operating the FutureSafe 2.0, proceed as described in the following troubleshooting table. Contact the customer service department if faults are encountered which cannot be remedied using the information and measures given in the table.

Fault	Possible Cause	Remedial Measures
The latches do not engage correctly.	Foreign objects have found their way into the latches.	Inspect the latches and remove any foreign objects, clean the latches if necessary.
The FutureSafe 2.0 makes noises when driving.	The FutureSafe 2.0 anchorage has become loose.	Check tighten all fastening bolts / screws.
The height of the head- and back supports cannot be adjusted.	The guide or latch bushing is dirty or defective.	Inspect the guide and latch bushings. Clean or replace as necessary.

10 Spare Parts and Accessories

10.1 Spare parts







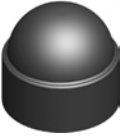

Figure	Designation	Article No.
	Head support	200934430
	Back support	200934427
	Belt without height adjustment	H350225
	Belt with height adjustment	H450235
	Guide for head or back support	200249429

Figure	Designation	Article No.
	Latch bushing for head or back support	200249725
	Hex. protective cap SW17	10008439
	Unlatching button	300101254

10.2 Accessories (optional)

Figure	Designation	Article No.
	Cushion for the head support Length = 300 mm, Thickness = 60 mm	200936407
	Cushion for the head support Length = 300 mm, Thickness = 90 mm	200937552
	Cushion for the head support Length = 300 mm, Thickness = 120 mm	200937553
	Cushion for the back support Length = 350 mm, Thickness = 60 mm	200936407
	Cushion for the back support Length = 350 mm, Thickness = 90 mm	200937552
	Cushion for the back support Length = 350 mm, Thickness = 120 mm	200937553

11 Customer Service

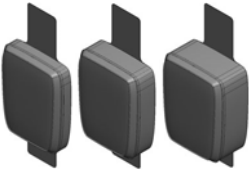
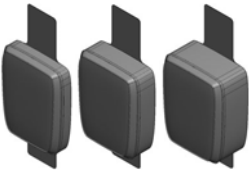
The AMF-Brunns customer service department will be more than pleased to assist in ordering spare parts, maintenance and repair work and help with general problems or queries.

The address is:

AMF-Brunns GmbH & Co. KG
Hauptstraße 101
D - 26689 Apen

Tel.: +49 (0) 44 89 / 72 72-22

Fax: +49 (0) 44 89 / 62 45

service.hubmatik@amf-bruns.de

www.amf-bruns.de

NOTE



Guarantee work on the FutureSafe 2.0 must only be carried out with the prior agreement of AMF-Brunns GmbH & Co. KG.

The costs of such work will not be accepted by AMF-Brunns without prior agreement.



AMF-Brunns GmbH & Co. KG
Hauptstraße 101 | D-26689 Apen
Telephone +49 (0) 44 89 / 72 72 22
Fax +49 (0) 44 89 / 62 45
service.hubmatik@amf-bruns.de

www.amf-bruns.de



DIN EN ISO 9001
REG.-NR. 01 0105027